



**English**

Read this document carefully to use this product safely and correctly.

If your product is faulty, please read the included warranty card and consult the store you purchased it from. If you require further assistance contact your local EPSON customer support centre.

Please also find below the URL for the support centre:  
<http://www.epson.co.uk/support>



**Part Names**

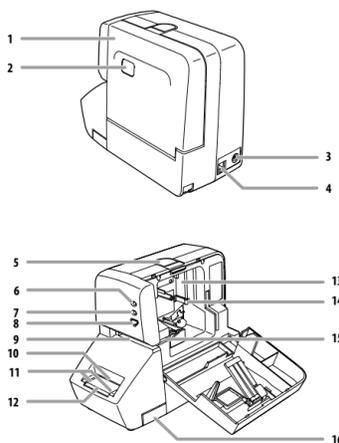

1. Compartment cover
2. Tape confirmation window
3. Power socket
4. USB connector
5. Cover release button
6. Power lamp
7. Half-cut lamp
8. Feed button
9. Tape outlet slot
10. Trimmer inlet slot
11. Trimmer guide
12. Trimmer table
13. Tape cartridge compartment
14. Securing hook
15. Tape guide
16. Trimmer box

**Before use**

**1. Connecting Cables**

**MEMO**  
This product does not have a power switch. The power turns ON automatically if the AC adapter and the USB cable are connected. When the power is ON, the power lamp on the front lights.  
To check the status of the power lamp  
☞ Feeding the power lamp and half-cut lamp

**Connecting the AC adapter**

- ① Make sure to use the dedicated AC adapter (AST1527Z).

1. Insert the plug of the AC adapter firmly into the power socket on the rear of the product.
2. Insert the power plug of the AC adapter into the outlet.

① Do not unplug the AC adapter or USB cable while printing or feeding tape. Doing so interrupts printing or tape feeding, and may cause damage to the product.

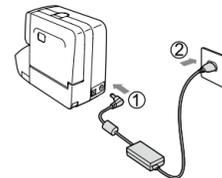

**Connecting to your computer**

**MEMO**  
Before connecting the product to your computer, make sure to confirm the printer driver is installed on it.  
If the product is connected to the computer without the printer driver installed, the "found new hardware" wizard screen appears. Click [Cancel], and install the printer driver before use.  
How to install the driver ☞ Label Editor User's Guide

Turn the computer on in advance.

1. Connect the USB cable to the product.



① Make sure to use the supplied USB cable.

2. Connect the other end of the USB cable to the USB terminal on the computer.

To the computer



**MEMO**  
• Confirm the shape and the direction of the connector before connecting the USB cable.  
• Do not use a USB hub.  
• When connecting two or more products to one computer ☞ Label Editor User's Guide

**2. Installing a tape cartridge**

1. Remove the slack of the ink ribbon.



2. Press the cover release button to open the compartment cover.

① Do not hold the product by the cover.

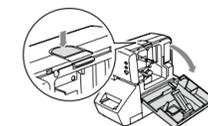

**3. Install a tape cartridge.**

Insert it firmly as far as it will go.

When installing a new tape or the tip of the tape is longer than usual, put the tape through the tape guide.

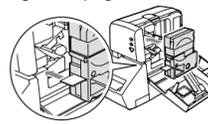

① Do not pull out the tape forcibly by hand.

4. Close the cover. Press the upper centre of the cover until it closes and snaps into place.



① Be sure to insert the tape cartridge firmly as far as it will go. If the cover is closed without inserting the tape cartridge fully, the product or the tape cartridge may get damaged.

**How to remove the tape cartridge**

- ① Hold the cartridge by the tabs, and pull it straight out.

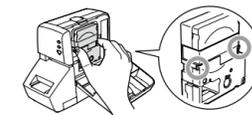

**3. Feeding the tape**

After setting a tape cartridge, make sure to feed tape.

1. Press on the product.  
Feed and Cut: Feeds the tape about 20mm and cuts it.  
Feed: Feeds the tape about 20mm.

**4. Editing and printing a label**

You can create label designs on your computer using the supplied editing software, then print the labels you created using this product. When using the product for the first time, install the supplied dedicated printer driver and editing software. For information on installation and operation of the software ☞ Label Editor User's Guide



**5. Printing labels**

☞ Label Editor User's Guide

**■ Rounding off the corners**

The corners of printed labels can be rounded off by inserting them into the trimmer. Rounded labels can look better, and the rounded corners make the labels less likely to peel away after sticking.

1. Align a label to the trimmer guide on the trimmer table, then insert it as far as it will go.

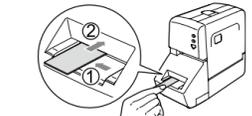

When trimming a "half-cut" label, fold it at the cut line, then insert it into the trimmer inlet slot with the fold first.



2. Once the sound of cutting has stopped, take the label out. If the corners are not sufficiently rounded, repeat the trimming process.
3. Turn over and align the label with the trimmer guide to trim the other end, then insert and trim it.

⚠ The trimmer does not function while printing labels or when the compartment cover is open.  
• Be sure to insert the label thoroughly as far as it will go. Also, insert it straight along the trimmer guide. Otherwise, the label may not be trimmed correctly.  
• Make sure the cutting sounds have stopped before taking the label out. If the label is removed during trimming, it may not be trimmed correctly. If not, do it all over again.  
• Do not move the label when it is inserted in the trimmer. If it is moved, it will be misaligned and may not be rounded off correctly.  
• 6mm-wide labels cannot be trimmed.  
• At the time of purchase, some paper chips may remain in the trimmer box attributed to the cut test in the manufacturing process.

**6. Attaching labels**

1. Peel off the backing paper.
2. Attach the label and rub it firmly.

**■ Turn the power off after use**

1. Disconnect the USB cable. Disconnect it from both the product and the computer.
2. Unplug the AC adapter. Unplug it from the outlet and the power socket of the product.

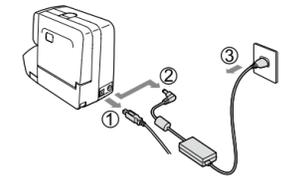

**MEMO**  
To turn the power off, just unplug the AC adapter.  
**If you do not use the product for a long time**  
Remove the tape cartridge, and unplug the AC adapter and USB cable from the product if you do not use the product for a long time. Keep the product, AC adapter, USB cable and tape cartridges in a cool, dark place away from direct sunlight, high temperature or humidity, magnetised items, vibrations or dust.

**Safety Instructions**

For your safety, read the attached documents carefully to use this product correctly. After you have read all instructions, keep this manual handy for future reference and to make your concerns clear. Items below indicate safety precautions to protect users, their surroundings and their property from possible injury or damage. Precautionary notations are categorised as follows according to personal injury and damage to the equipment if the instructions are ignored or the equipment is misused.

- ⚠ **WARNING**  
This symbol indicates information that, if ignored, could possibly result in serious personal injury or even death due to incorrect handling.
- ⚠ **CAUTION**  
This symbol indicates information that, if ignored, could possibly result in personal injury or physical damage due to incorrect handling.

The following describes the meaning of each symbol used in the precautions.

- ⚠ This indicates an important reminder.
- ⊘ This indicates a prohibited item.
- ⓘ This indicates a mandatory procedure.

**⚠ WARNING**  
**When using the AC adapter and power cable**

- ⊘ Do not use any AC adapter or power cable other than the dedicated AC adapter and power cable. Do not use the AC adapter with other than the specified voltage also. Otherwise, damage, overheating, fire or electric shock may occur.
- ⊘ Take the following precautions when handling the AC adapter and power cable.
  - Make sure to avoid octopus wiring.
  - Make sure the plug is not dusty before inserting it into an outlet.
  - Insert the plug firmly into the outlet.
  - Do not hold the plug with wet hands.
  - Do not pull the power cable when disconnecting the plug. Be sure to hold the plug when disconnecting it.
  - Do not make any modification to the AC adapter or power cable.
  - Do not apply strong shocks to or put a heavy object on the AC adapter or power cable.
  - Do not bend or twist the AC adapter or power cable forcibly.
  - Do not place the AC adapter or power cable near a heater.

- ⊘ Do not use any damaged AC adapter or power cable. Otherwise, damage, overheating or smoking may occur, which may result in fire or electric shock.
- ⊘ Do not touch the plug during thunderstorms.

**When using this product**

⊘ Do not apply any strong force or shocks to the product such as standing on, dropping or hitting it. Otherwise, the product may be broken, which may result in fire or electric shock. If it is damaged, turn off the power immediately, unplug the AC adapter and then contact the EPSON customer support centre. Continuous use may result in fire or electric shock.

⚠ Take care not to spill any beverage such as tea, coffee or juice onto the product, or to spray aerosol insecticide. It may cause malfunction, fire, or electric shock. If any liquid has been spilled on the product, turn off the power, unplug the AC adapter immediately, and then contact the EPSON customer support centre. Continuous use may result in fire or electric shock.

⚠ Do not touch the printhead because it becomes very hot. Otherwise, there is a risk of burns.

⊘ Do not open any covers other than the compartment cover. Doing so may result in fire or electric shock. Always use the product as instructed in this manual. Otherwise, damage or injury may occur.

ⓘ If any of the following abnormalities is observed, turn off the power immediately, unplug the AC adapter, and then contact the EPSON customer support centre.
 

- If smoke, strange odours or unexpected noises come from the product
- If liquid or foreign objects get inside the product
- If the product has been dropped or damaged

**When handling the auto trimmer**

ⓘ When removing the trimmer box, make sure to turn the power off.  
If the product operates without the trimmer box, injury or damage may occur with the blade inside the product.  
When cleaning the trimmer box, do not touch the trimmer blade, as there is a risk of injury.

⊘ Do not insert anything other than labels into the trimmer inlet slot. Otherwise, damage to the trimmer may occur.

**When handling the auto cutter**

ⓘ Do not touch the tape outlet slot (where the labels come out) during printing or when the auto cutter is in operation. Otherwise, there is a risk of injury.

**When handling the half cutter**

ⓘ Do not touch the tape outlet slot (where the labels come out) during printing or when the auto cutter is in operation. Otherwise, there is a risk of injury.

**Others**

- ⊘ Do not use or store the product, AC adapter, power cable, USB cable or tape cartridges in the following places.
  - In direct sunlight.
  - Where it may become extremely hot such as in a vehicle with the windows closed.
  - Where it may become extremely hot such as near a heater or the temperature becomes very unstable such as near the exhaust duct of an air conditioner.
  - Where the product may get wet due to a shower or rain such as in a bathroom or outdoors.
  - In a dusty place or where the product may be exposed to smoke or steam such as in the kitchen or a humidifier.
  - On an unstable place such as on a shaky table or on an inclined plane.
  - Where it might be subjected to vibration or shock.
  - Near high-voltage power lines or something that generates a magnetic field.

ⓘ Keep the plastic bags used to contain the product or this manual out of reach of children. Children may suffocate if they swallow them or put their heads into the bags.

**⚠ CAUTION**

⊘ Do not use the AC adapter in a small, confined space, or cover it with a cloth. Otherwise, the AC adapter may overheat and deteriorate.

**When using this product**

⊘ Do not stand on the product or place it on an unstable place such as on a shaky table or on an incline. Otherwise, the product may fall and cause injury.

⚠ To ensure safety, unplug this product before leaving it unused.

ⓘ Before cleaning, make sure to unplug the AC adapter from the outlet.

⊘ Do not use a moistened cloth or solvents such as alcohol, thinner or benzine.

**Others**

- ⊘ The supplied disc is a data CD-ROM for computers. Do not play it in an audio CD player. Otherwise a very loud sound may be emitted, causing risk to both your hearing and your audio equipment.
- ⚠ Be careful of continuous use of this product, which may cause eye fatigue.

**■ When handling tape cartridges**

- Make sure to use a dedicated LC Tape.
- Some types of tape cannot be cut by the cutter or the trimmer. For the details, refer to the tape's manual.
- Do not drop it or disassemble it. Doing so may cause damage.
- Do not pull out the tape forcibly by hand. Otherwise, the tape cartridge may be broken and unusable. ☞ 3. Feeding the tape
- Avoid using a tape cartridge without remaining tape. Doing so may cause overheating of the printhead, which may result in damage or malfunction.

**MEMO**  
Tape cartridges contain ink ribbons. When disposing of tape cartridges, make sure to follow the local regulations for disposal.

**■ Other cautions**

- Do not touch the printhead.
- Take care not to cut your fingers when cutting the label with scissors.
- Do not attach a label on human bodies, living things, public facilities or other people's belongings.

**About the printed labels**

- Depending on the environment labels are used in and the nature of the object labels are attached to, the following issues may occur:  
Label: Discolouration, faded characters, peeling  
Adhesive side: Adhesive residue, staining, damage
- Carefully check the suitability of the label for the intended purpose before use. EPSON takes no responsibility for any damage or loss due to the above mentioned causes.

**Specifications**

**■ Body**

Dimensions	Approx. 85 (W) x 182 (D) x 146 (H) (mm)
Weight	Approx. 900g (excluding tape cartridge)

**■ Usage conditions**

Operating temperature	5 to 35 degrees C
Storage temperature	-10 to 55 degrees C

**■ Power supply**

AC adapter	Type	AST1527Z1-1
	Manufacturer	Seiko Epson Corp.
	Input	AC100-240V, 0.9A, 50-60Hz (dedicated adapter, power cable only)
	Output	DC15V, 2.7A
	Total output power	41W

**■ Supported tape width**  
6mm, 9mm, 12mm, 18mm, 24mm, 36mm

**Cleaning**

**When the exterior is dirty**  
Wipe the dirt off with a soft cloth. If it is very dirty, use a cloth wrung out of water.

- ① Never use chemicals or solvents such as benzine, thinner, or alcohol, or use a chemical duster.

**When the printhead is dirty**  
If the print becomes faint or some parts are missing, there may be some dirt on the printhead. Clean the print head with a cotton swab moistened with medical alcohol (commercially available ethanoh).

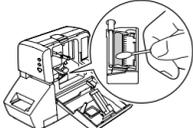

**Maintenance of the trimmer**

**■ Cleaning the trimmer**  
Remove the trimmer box and clean the trimmer periodically.

- ① Make sure to turn the power off before cleaning.

1. Unplug the AC adapter to turn the power off.
2. Remove the trimmer box. Pull the box out by the tab on the bottom.

4. Set the trimmer box back.

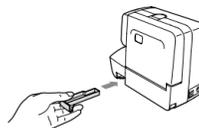

⚠ When removing the trimmer box, make sure to turn the power off. If the product operates without the trimmer box, injury or damage may occur with the blade inside the product. Keep your fingers away from the trimmer, as there is a risk of injury.

**■ Replacing the trimmer blade**  
The trimmer blade may eventually become worn and dull. If this happens, contact the EPSON customer support centre.

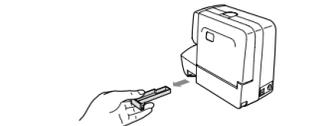

**Troubleshooting**

**■ Checking the power lamp and half-cut lamp**

You can check the status of the product with the lamps.

**Power lamp**

Status of the lamp	Status of the product	
ON	The power is on and the product is ready to operate.	
Blinks (Same interval for ON/OFF)	Slow blink	When preparing to print, printing or feeding.
	Fast blink	When cutting tape.
Blink (Interval for OFF is longer.)	In an error status. When a message appears on the computer screen: Check the content of message. When no message appears on the computer screen: Check the status of the cover and the tape cartridge of the product. If not improved, unplug the AC adapter once. If the error occurs again even though the AC adapter is reconnected, contact the EPSON customer support centre.	
OFF	The power is OFF. The power turns ON automatically if the AC adapter and the USB cable are connected to the product. Check the connection of the cables.	

**Half-cut lamp**

Status of the lamp	Status of the product
ON	When printing a label with the half-cut setting enabled.
Blinks (Same interval for ON/OFF)	When making a half-cut.
Blink (Interval for OFF is longer.)	In an error status. When a message appears on the computer screen: Check the content of message. When no message appears on the computer screen: Check the status of the cover and the tape cartridge of the product. If not improved, unplug the AC adapter once. If the error occurs again even though the AC adapter is reconnected, contact the EPSON customer support centre.
OFF	The half-cut setting is disabled.

**■ Problems**

**The product does not work if a print job is sent.**

Is there any message displayed on the computer screen? Check the content of message.
Is the printer driver installed? Install the printer driver. ☞ Label Editor User's Guide
Did you reboot the computer after installing the printer driver? The printer driver may not be installed correctly unless the computer is rebooted. Re-install the printer driver. ☞ Label Editor User's Guide
Is the product correctly connected to the computer? Check the cable connecting the product and the printer. ☞ Connecting to your computer
Is the AC adapter connected? Check the connection of the AC adapter. ☞ Connecting the AC adapter
Is the selected printer correct? If a wrong printer is selected, printing cannot be done normally. ☞ Label Editor User's Guide

**The power cannot be turned ON/OFF.**

Is the power lamp ON? This product does not have any power switch. The power turns ON automatically if the AC adapter and the USB cable are connected. To turn the power off, unplug the AC adapter from the product.

**Characters are missing or faint.**

Is the print head dirty? Clean the print head. ☞ When the printhead is dirty

**The label is not automatically cut.**

Is "Don't cut" selected? Check the settings of the printer driver.  
Is the cutter blade worn? The cutter blade can eventually become dull and worn. If this happens, contact the EPSON customer support centre for advice.

**Unable to trim the label correctly.**

Did you trim it during printing? The trimmer does not work during printing.
Is the compartment cover open? The trimmer does not work if the compartment cover is open. Close the cover.
Did you insert the label to the trimmer inlet slot correctly? Insert the label straight along the trimmer guide. ☞ Rounding off the corners
Is the trimmer box full of paper chips? Take out the trimmer box and remove the paper chips. ☞ Cleaning the trimmer
Is the trimmer blade worn? The cutter blade can eventually become dull and worn. If this happens, contact the EPSON customer support centre for advice.

**Half-cut cannot be made correctly.**

Is the "Half cut" setting enabled? Check the settings of the printer driver.
Is "Don't half cut" selected? Check the settings of the printer driver.
Is the blade for half-cut worn? The cutter blade can eventually become dull and worn. If this happens, contact the EPSON customer support centre for advice.

**Unable to attach labels.**

Did you peel off the backing paper? Peel off the backing paper before attaching the label.
Are you attaching it to a dirty or rough surface? The label may not adhere due to the material of the attachment location or the environmental conditions.

**MEMO**  
If none of the above has solved the problem or the symptom is other than the above, contact the EPSON customer support centre.